

# SAF520 22dBA Super Silent Power Supply 520W-P4 Specification

Version 2.0 - SATA

## **Contents PS2 ATX12V – P4**

<b>1. General Specification</b> .....	<b>3</b>
1.1 Physical Dimension .....	3
1.2 DC Connector Pin Description .....	4
1.3 Environmental .....	5
1.3.1 Operating .....	5
1.3.2 None Operating .....	5
1.4 Fan Control Function .....	6
1.5 Reliability / Mean Time Between Failure (MTBF) .....	6
1.6 EMI .....	6
1.7 Safety / Agency Approvals .....	7
1.8 Csea Fan Control Function .....	7
1.9 Fan speed detection .....	7
<b>2. Introduction</b> .....	<b>8</b>
2.1 Scope .....	8
2.2 General Description .....	8
<b>3. AC Input</b> .....	<b>8</b>
3.1 Voltage Range .....	8
3.2 Frequency Range .....	8
3.3 Input Waveform .....	8
3.4 Input Current .....	8
3.4.1 Steady-state Current .....	8
3.4.2 Cold Start Inrush Current .....	8
3.4.3 Warm Start Inrush Current .....	9
3.4.4 Power Factor Correction (PFC) .....	9
3.4.5 Input Overcurrent Protection .....	9
3.4.6 Withstand Voltage .....	9
3.4.7 Catastrophic Failure Protection .....	10

# SAF520 22dBA Super Silent Power Supply 520W-P4 Specification

Version 2.0 - SATA

<b>4. DC Output .....</b>	<b>10</b>
4.1 Output Voltage .....	10
4.2 Output Regulation .....	10
4.2.1 Output Voltage Load Regulation .....	11
4.2.2 Output Voltage Line Regulation .....	11
4.2.3 Cross Regulation .....	11
4.3 Efficiency .....	11
4.4 Output Periodic And Random Deviation (PARD) .....	12
4.4.1 Common Mode PARD (Noise) .....	12
4.4.2 Differential Mode PARD (Ripple) .....	12
4.5 Output Transient Response .....	13
4.6 Close-loop Stability .....	14
4.7 Voltage Hold-up Time .....	14
4.8 Power Sequencing .....	14
4.9 Timing / Housekeeping / Control .....	15
4.9.1 PWR_OK .....	15
4.9.2 PS_ON # Signal .....	16
4.9.3 +5VSB .....	16
4.9.4 Power –on Time .....	16
4.9.5 Output Risetime .....	16
4.9.6 Overshoot at Turn-on / Turn-off .....	16
4.9.7 Reset after Shutdown .....	17
4.10 Output Protection .....	17
4.10.1 Over Current Protection .....	17
4.10.2 Over Voltage Protection .....	17
4.10.3 Short Circuit Protection .....	17

# 1. SAF 520 General Specifications PS2 ATX12V – P4

(Version - SATA)

## 1.1 Physical Dimension

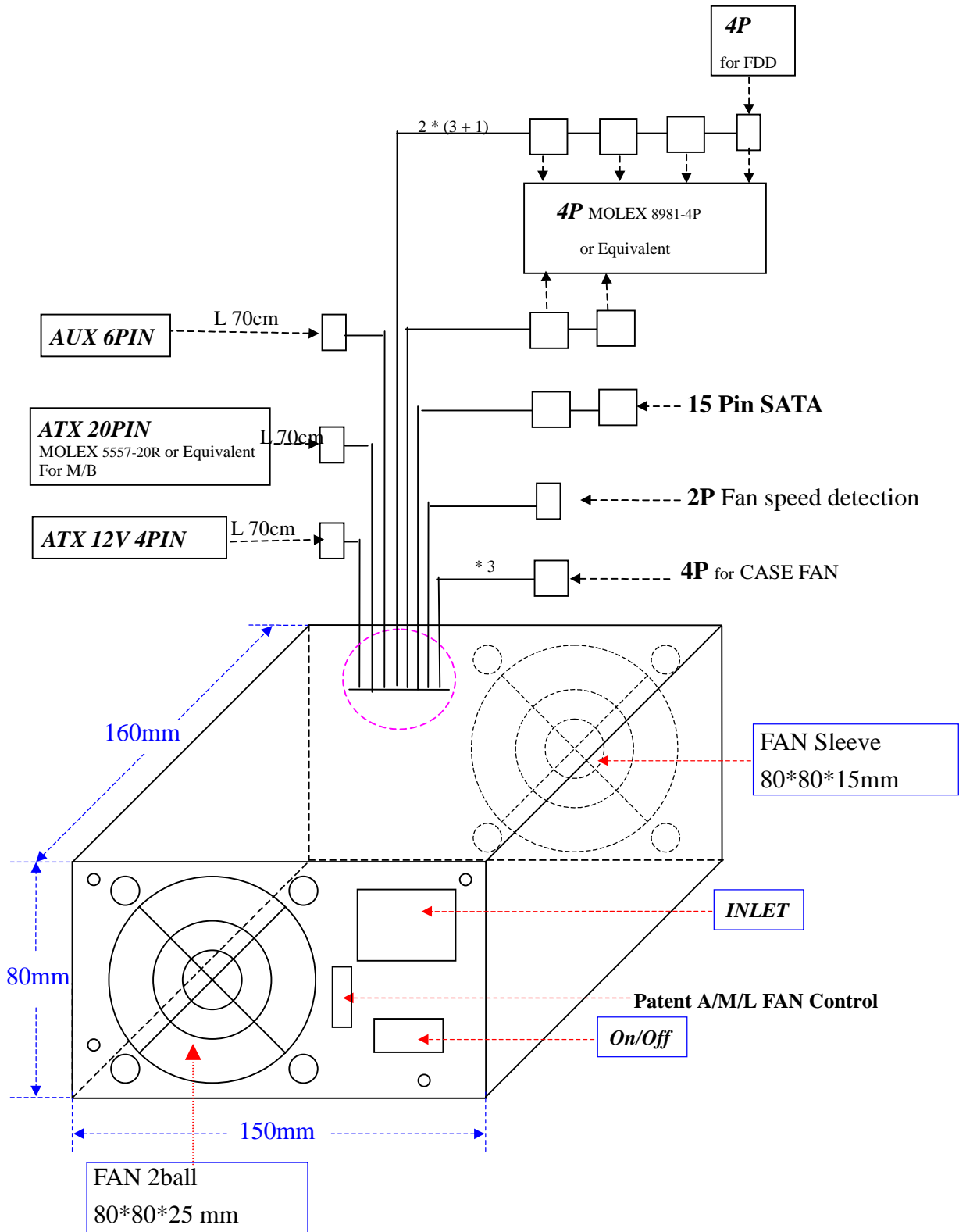

## 1.2 DC Connector Pin Description

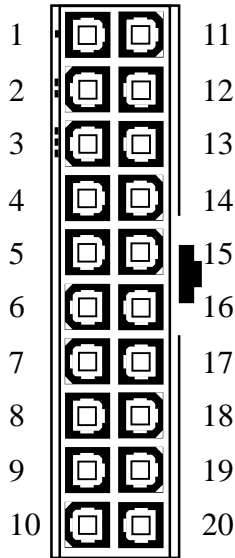

Pin	Color	Signal	Pin	Color	Signal
1	Orange	+3.3VDC	11	Orange Brown	+3.3VDC +3.3V default sense
2	Orange	+3.3VDC	12	Blue	-12VDC
3	Black	COM	13	Black	COM
4	Red	+5VDC	14	Green	PS_ON/OFF
5	Black	COM	15	Black	COM
6	Red	+5VDC	16	Black	COM
7	Black	COM	17	Black	COM
8	Gray	PWR_OK	18	White	-5VDC
9	Purple	+5VSB	19	Red	+5VDC
10	Yellow	+12VDC	20	Red	+5VDC

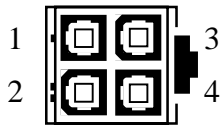

Pin	Color	Signal	Pin	Color	Signal
1	Black	COM	3	Yellow	+12VDC
2	Black	COM	4	Yellow	+12VDC

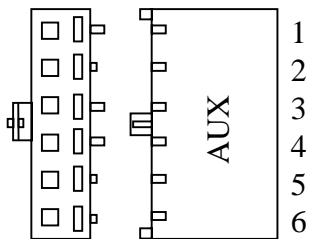

Pin	Color	Signal	Pin	Color	Signal
1	Black	COM	4	Orange	+3.3VDC
2	Black	COM	5	Orange	+3.3VDC
3	Black	COM	6	Red	+5VDC

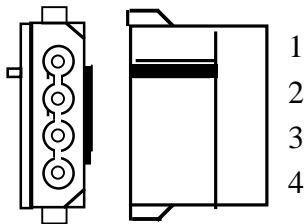

Pin	Color	Signal	Pin	Color	Signal
1	Yellow	+12VDC	3	Black	COM
2	Black	COM	4	Red	+5VDC

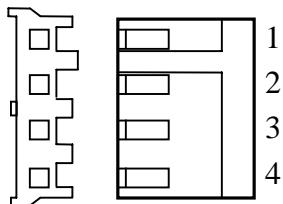

Pin	Color	Signal	Pin	Color	Signal
1	Red	+5VDC	3	Black	COM
2	Black	COM	4	Yellow	+12VDC

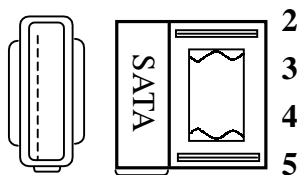

Pin	Color	Wire Size	Signal
2	Black	UL1007#18AWG	GND
3	Red	UL1007#18AWG	+5V
4	Black	UL1007#18AWG	GND
5	Yellow	UL1007#18AWG	+12V

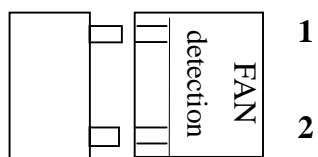

Pin	Color	Signal
1	White	Fan Monitor
2	Black	GND

### 1.3 Environmental

#### 1.3.1 Environmental (Operating)

Temperature: 0°C to 50°C

Humidity: 20% to 80% Relative Humidity (non condensing)

Altitude: -61meters to +3,048 meters

Shock: T.B.S.

Vibration: T.B.S.

#### 1.3.2 Environmental (Non-Operating)

Temperature: -25°C to 85°C

Humidity: 10% to 90% Relative Humidity (non condensing)

Altitude: -61meters to +15,244 meters

Shock: T.B.S.

Vibration: T.B.S.

#### 1.4 Fan Control Function

In order to prolong the fan's life cycle, the power supply is facilitated with a thermostatic circuitry to monitor the fan speed under the power supply operating temperature.

**R.P.M** *FAN SPEED CURVE: 800RPM~2,500RPM* ± 100 R.P.M

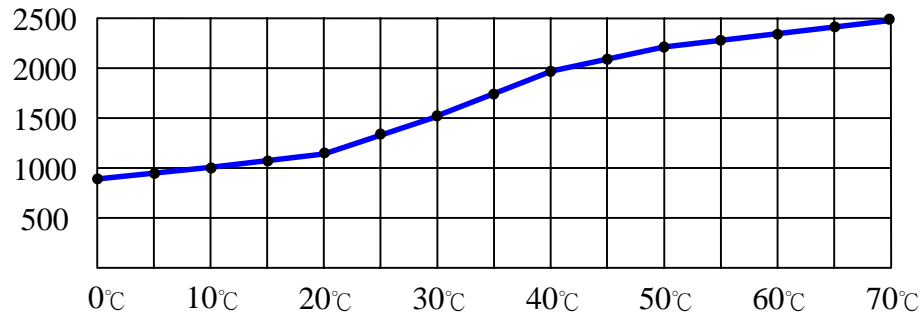

#### 1.5 Reliability / MTBF

The power supply reliability is based on the calculation with the Part-Stress Analysis method of MIL-HDBK-217F using the quality factors listed in MIL-HDBK-217F. The power supply MTBF is 140,000 hours under the following conditions:

- Full-rated load
- 220 (or 110)VAC input
- Ground begin
- 25°C ambient
- 

#### 1.6 EMI

The power supply is complied with CISPR 22, Class B. Tests are performed at 110VAC 50Hz, 120VAC 60Hz, and 220VAC 50 Hz power. The 22dBA 520W-P4 (w/PFC) version meets the requirement of EN 61000-3-2 Class D, and EN 61000-3-3, and the Guidelines for the Suppression of Harmonics in Appliances and General Use Equipment Class D for harmonic line current content at full-rated power.

## 1.7 Safety / Agency Approval

UL	1950
CSA	C22.2
ICE	950
TUV	EN60950
CE	EN 61000-3-2/1995, EN 61000-3-3/1995 EN 55024/1998, EN 5022/1994+A1: 1995+A2: 1997
FCC	Part 15, Subpart B, Class B CISPR 22: 1993+A1: 1995+A2: 1996, Class B ANSI C63.4-1992

## 1.8 Case Fan Control Function

Patent Thermal Fan Controller can control up to 5 fans at the same time  
( 2 fans in PSU and 3 case fans ).

3 options available : Auto , Medium , Low

Auto : Fan speed automatically adjusted according to system temperature .

Low : Low Speed

Middle : Middle Speed

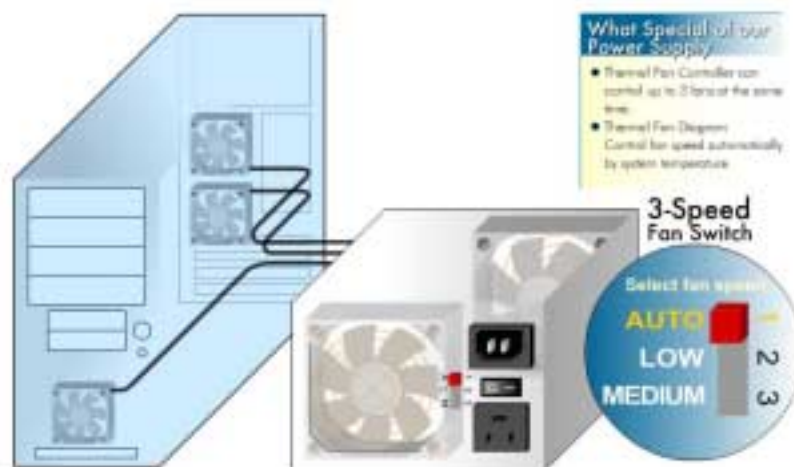

## 1.9 Fan speed detection

The 2 pin fan speed detection cable (wire color : black/white) is for fan speed detection purpose. Please plug it to the fan header on the mainboard.

## **2. Introduction**

### **2.1 Scope**

This specification defines the performance and characteristic for the model of SAF520 Super Silent 520W-P4 PS2 ATX12V power supply.

### **2.2 General Description**

SAF520 520W-P4 is a switching power supply, 520W self-contained, AC to DC power source supply suitable for mounting in PC, Server Tower and IPC Chassis.

## **3. AC Input**

### **3.1 Voltage Range**

AUTO Active PFC Version : 95VAC ~ 250VAC .

Active PFC 220V Only Version : 190VAC ~ 250VAC .

### **3.2 Frequency Range**

Frequency range: 47Hz – 63Hz

### **3.3 Input Waveform**

Input waveform: Sine wave, modified sine wave or square wave

### **3.4 Input Current**

#### **3.4.1 Steady-state Current**

Maximum current at 115 VAC (RMS): 12A

Maximum current at 230 VAC (RMS): 6A

#### **3.4.2 Cold Start Inrush Current**

Maximum inrush current at 115 VAC: 30A

Maximum inrush current at 230 VAC: 60A

Inrush duration: 200 ms

\* Measured at 25°C ambient cold start, power supply has been off for 60 seconds or longer.

### 3.4.3 Warm Start Inrush Current

Maximum inrush current at 115 VAC:	35A
Maximum inrush current at 230 VAC:	70A
Inrush duration:	200 ms

\* Measured at 25°C ambient cold start, power supply has been off for 200ms to 60 seconds.

### 3.4.4 Power Factor Correction (Active PFC)

AUTO Active PFC :

SAF520 520W-P4 (w/PFC) version is facilitated with the universal input 95VAC ~ 250VAC active PFC with the PF value  $\geq 0.960$

Active PFC 220V Only :

SAF520 Silent 520W-P4 (w/PFC) version is facilitated with the 220V only input is 190VAC ~ 250VAC active PFC with the PF value  $\geq 0.960$

#### 115V (Nominal) Operation

PFC reaches 96.0% at 115V, 60Hz, under full output loading in accordance with the EN 61000-3-2, class D standards.

#### 230V (Nominal) Operation

PFC reaches 96.0% at 230V, 50Hz, under full output loading in accordance with the EN 61000-3-2, class D standards.

### 3.4.5 Input Overcurrent Protection

The power supply is equipped with a non-reset-able fuse on the AC input to limit power consumption on a failure within the power supply module.

#### Input Fuse Rating:

Voltage	250 V
Current	10 A
De-activation time	200 ms

### 3.4.6 Withstand Voltage

The power supply is capable of withstanding a maximum 2200 VDC potential between the input and ground for a period of 1 minute.

### 3.4.7 Catastrophic Failure Protection

If a component failure occurs, the power supply will not exhibit any of the following:

- \* Flame
- \* Excessive smoke
- \* Charred PCB
- \* Fused PCB conductor
- \* Startling noise
- \* Emission of molten material

## 4. DC Output

### 4.1 Output Voltage

Table 1 below summarizes the minimum DC output voltages and associated power requirements for each output.

DC Nominal Voltage	Minimum Current	Maximum Current	Peak Current
+12 V DC	0.0 A	28.0 A	30.0 A
+5 V DC	0.1 A	52.0 A	58.0 A
+3.3 V DC	0.3 A	26.0 A	28.0 A
-5 V DC	0.0 A	0.5 A	0.8 A
-12 V DC	0.0 A	0.8 A	1.0 A
+5 V SB	0.0 A	2.0 A	2.5 A

- ( + 5V and +3.3V combined output 260W )
- ( + 5V and +3.3V and +12V combined output 500W )

**Table 1. DC Output Specifications**

NOTE: Peak current is limited to total duration of 60 seconds from the instance of PWROK driven true. The power supply is able to sustain maximum current for an unlimited time after these initial 60 seconds.

### 4.2 Output Regulation

The DC voltage outputs will stay within the regulation band as measured at the terminal outputs due to any combination of the following conditions:

- Input voltage fluctuations
- Specified load range
- Centering
- Specified environmental conditions
- Changing load steps

#### 4.2.1 Output voltage load regulation

The following table summarizes the allowable output voltage tolerances for each output rail.

DC Nominal Output	Output Voltage Tolerance
+12V DC	± 5%
+5V DC	± 5%
+3.3V DC	± 5%
-5V DC	± 10%
-12V DC	± 10%
5V SB	± 5%

**Table 2. DC Output Tolerance Specifications**

#### 4.2.2 Output Voltage Line Regulation

The following table specifies line regulation as measured from maximum load including the transient response requirements as detailed in this document.

DC Nominal Output	Output Voltage Tolerance
+12V DC	± 1%
+5V DC	± 1%
+3.3V DC	± 1%
-5V DC	± 1%
-12V DC	± 2%
5V SB	± 1%

**Table 3. DC Output Tolerance Specifications**

#### 4.2.3 Cross Regulation

The power supply DC outputs perform within all line and load specifications regardless of the static or transient loads on any of the outputs.

### 4.3 Efficiency

68% minimum at 115VAC, 520W output.

#### 4.4 Output Periodic And Random Deviation (PARD)

There are two types of noise (PARD) specifications to be considered on the power supply; Common Mode and Differential Mode. Common mode is referred to as noise that is common between the specified voltage output and the associated ground line. Differential mode refers to noise that is only measured on the specified DC voltage output. In either case, noise is within the frequency range of 10 Hz – 20MHz and specifications are rated over the full output range for the power supply. Tables 4 and 5 provide the details for this specification.

##### 4.4.1 Common Mode PARD (Noise)

DC Output	Common Mode PARD Specification
+12V DC	$\leq 240\text{mv(pk-pk)}$
+5V DC	$\leq 100\text{mv(pk-pk)}$
+3.3V DC	$\leq 100\text{mv(pk-pk)}$
-5V DC	$\leq 100\text{mv(pk-pk)}$
-12V DC	$\leq 240\text{mv(pk-pk)}$
5V SB	$\leq 100\text{mv(pk-pk)}$

**Table 4. DC Output Common Mode PARD Specifications**

##### 4.4.2 Differential Mode PARD (Ripple)

DC Output	Differential Mode PARD Requirement
+12VDC	$\leq 120\text{mv(pk-pk)}$
+5VDC	$\leq 50\text{mv(pk-pk)}$
+3.3VDC	$\leq 50\text{mv(pk-pk)}$
-5VDC	$\leq 50\text{mv(pk-pk)}$
-12VDC	$\leq 120\text{mv(pk-pk)}$
5VSB	$\leq 50\text{mv(pk-pk)}$

**Table 5. DC Output Differential Mode PARD Specifications**

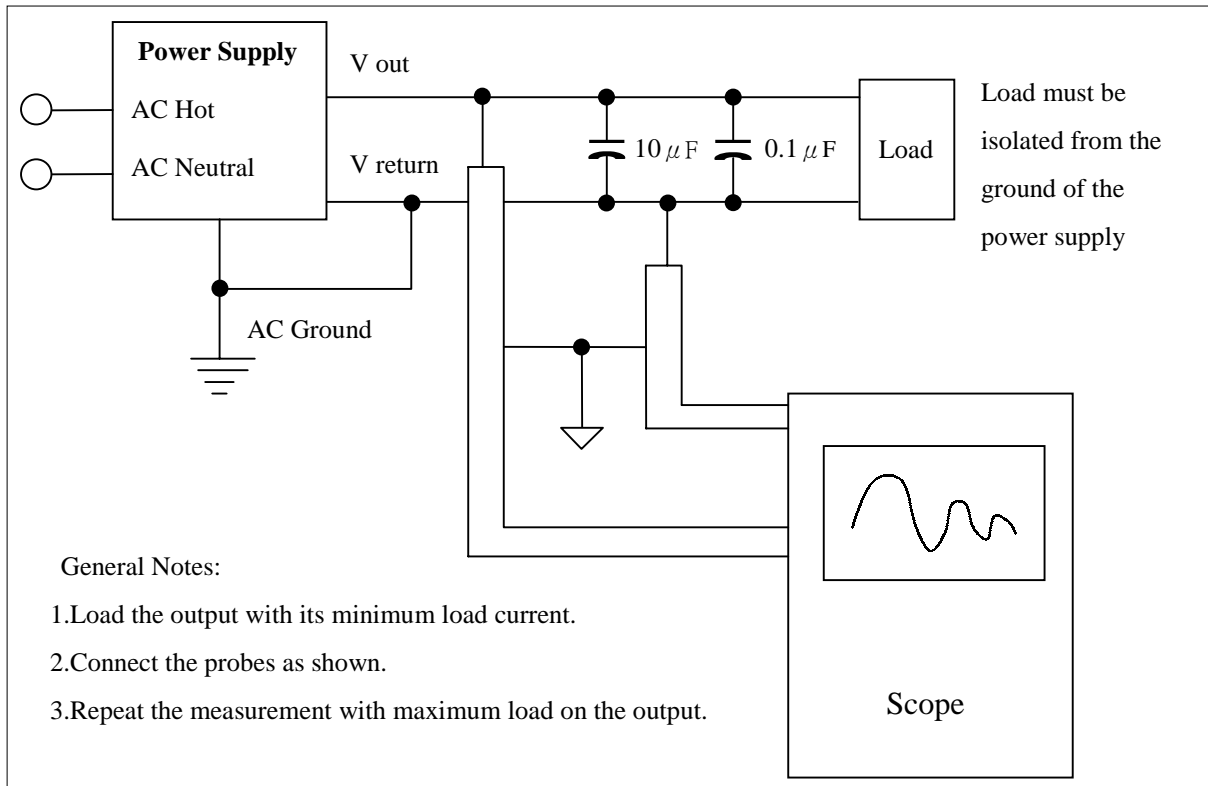

#### 4.5 Output Transient Response

The table below summarizes the output transient steps for each output. The Transient slew rate is  $=1.0A/\mu s$ .

DC Output	Maximum Step Size	Output Voltage Tolerance
+12VDC	50% of rated output	$\pm 5\%$
+5VDC	50% of rated output	$\pm 5\%$
+3.3VDC	30% of rated output	$\pm 5\%$
-5VDC	.1A	$\pm 10\%$
-12VDC	.1A	$\pm 10\%$
5VSB	.1A	$\pm 5\%$

**Table 6. DC Output Transient Response Specifications**

#### 4.6 Close-loop Stability

The power supply is unconditionally stable under all line/load/transient load conditions including capacitive loads specified in Table 7. A minimum of 45 degrees phase margin and 10 dB gain margin is at both the maximum and minimum loads.

DC Output	ATX12V Capacitive Load ( $\mu$ F)
+12 VDC	20,000
+5 VDC	10,000
+3.3 VDC	6,000
-5 VDC	350
-12 VDC	350
5 VSB	350

**Table 7. Output Capacitive Loads**

#### 4.7 Voltage Hold-up Time

All output will stay within regulation for at least 16.6ms after an AC line voltage failure is detected at nominal line (115VAC or 230VAC) under full load condition.

#### 4.8 Power Sequencing

All outputs, regardless of loading, turn on within 50ms of each other. The 5VSB output is in regulation for a minimum of 10ms prior to the other output rails reaching regulation.

## 4.9 Timing / Housekeeping / Control

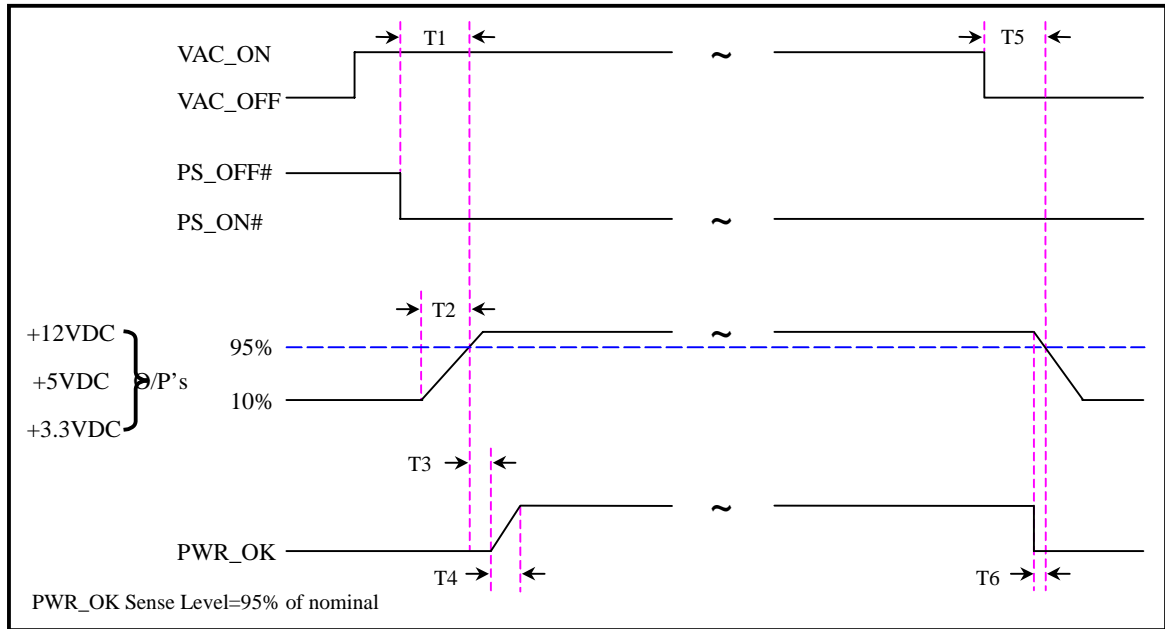

$T1 < 100\text{ms}$
$0.1\text{ms} \leq T2 \leq 20\text{ms}$
$100\text{ms} < T3 < 500\text{ms}$
$T4 \leq 10\text{ms}$
$T5 \geq 16\text{ms}$
$T6 \geq 1\text{ms}$

T1 : Power-on Time
T2 : Rise Time
T3 : PWR_OK Delay
T4 : PWR_OK Risetime
T5 : AC Loss to PWR_OK Hold-up Time
T6 : Power-down Warning

**Figure 1 Power Supply Timing**

### 4.9.1 PWR\_OK

The power supply accepts a logic collector level which will disable/enable all the output voltages. As the logic level is low, output voltages are enable; As the logic level is high, output voltages are disable. The definition of logic low/high level is as:

High Level: 2.50V ~ 5.25V while sourcing 0.4mA maximum

Low Level: 0.0V ~ 0.50V while sinking 5.0mA maximum

Rise Time: 3.0ms maximum (10.0% ~ 90.0%)

#### 4.9.2 PS\_ON# Signal

The power supply provides an internal pull-up to TTL high. The power supply also provides debounce circuitry on PS\_ON# to prevent it from oscillating on/off at startup when activated by a mechanical switch. The DC output enable circuitry is SELV-complaint.

	<b>Min.</b>	<b>Max.</b>
V <sub>IL</sub> , Input Low Voltage	0.0V	0.8V
V <sub>IL</sub> , Input Low Current (V <sub>in</sub> = 0.4 V)		-1.6mA
V <sub>IH</sub> , Input High Voltage (I <sub>in</sub> = -200 $\mu$ A)	2.0V	
V <sub>IH</sub> , open circuit, I <sub>in</sub> = 0		5.25V

**Table 8. PS\_ON# Signal Characteristics**

#### 4.9.3 +5VSB

The +5VSB is capable of delivering a minimum of 2.0A (Peak at 2.5A) at +5V  $\pm$  5% to external circuit. The power supply +5VSB is with overcurrent protection.

#### 4.9.4 Power-on Time

The power-on time is less than 100ms (T<sub>1</sub> < 100ms). The +5VSB has a power-on time of two seconds maximum after application of valid AC voltages. (Figure 1)

#### 4.9.5 Output Risetime

The output voltages rise from  $\leq$  10% of nominal to within the regulation ranges within 0.1ms to 20ms (0.1ms  $\leq$  T<sub>2</sub>  $\leq$  20ms). (Figure 1)

#### 4.9.6 Overshoot at Turn-on / Turn-off

Any overshoot at turn on or turn off is under 10% of the nominal DC output voltage with further stipulation that all DC outputs are within their specified DC voltage ranges before the generation of the power good signal. Additionally, no voltage may undershoot or overshoot once the power good signal has been asserted.

#### **4.9.7 Reset after Shutdown**

The power supply latches into a shutdown state because of a fault condition on its outputs, the power supply returns to normal operating after the fault has been removed and the PS\_ON# (or AC input) has been cycled OFF/ON with a minimum OFF time of 1 second.

### **4.10 Output Protection**

Each DC output is protected from over voltage, over current and short circuit. The following sections include the details for these protection mechanisms.

#### **4.10.1 Over Current Protection**

The power supply DC outputs are protected from supplying output current above the maximum ratings defined in Table 1, and when output power is between 110%~150%. With the exception of the 5VSB output, all DC outputs are latched off in the event of an over-current event on any of the DC outputs. In the event of a short circuit on any output, except the 5VSB rail, all outputs are disabled and remain disabled until the power supply is powered off back on. The 5VSB rail will recover upon removal of the over current condition.

#### **4.10.2 Over Voltage Protection**

The overvoltage sense circuitry and reference reside in packages that are separate and distinct from the regulator control circuitry and reference. No single point fault is able to cause a sustained overvoltage condition on any or all outputs. The power supply provides latch-mode overvoltage protection defined as:

+5V output is between 5.8V to 6.3V

+12V output is between 14.0V to 17.0V

+3.3V output is between 3.6V to 4.2V

#### **4.10.3 Short Circuit Protection**

The power supply DC outputs are protected from damage due to faults, when any output shorts to ground. In the event of a short circuit on any output, all outputs shall be disabled and remain disabled until the power supply is powered off and back on. The 5VSB rail will recover upon removal of the over current condition.